

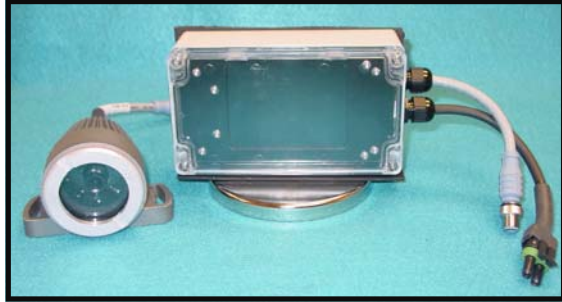

# MINING CONTROLS INC.

P.O. Box 1141 Beckley, WV 304-252-6243

## MODEL 7030-35365-17 NON-XP CAMERA SYSTEM



### COMPLETE NON-XP CAMERA SYSTEMS CONSISTING OF:

- 1 EACH MODEL 33665-60 NON-XP, SINGLE 4" MONITOR ENCLOSURE
- 1 EACH MODEL 33665-62 NON-XP, SINGLE 4" MONITOR ENCLOSURE
- 2 EACH MODEL 35610 CAMERAS, BLACK & WHITE, 600 LINES, 0.0003 LUX, LOW LIGHT, 12 VOLT AC/DC, 0.120 AMPS
- 2 EACH 7030-34828-75 75 ft. VIDEO AND POWER CABLE FOR CAMERA SYSTEMS
- 2 EACH 2023-35600-1 20 ft. CABLE, #18/2 SJOW

#### 7030-33665-60

SINGLE 4" LCD MONITOR ENCLOSURE, 12 VOLT DC FOR UNDERGROUND USE WITH 5 PIN CONNECTORS ( WITH RIGHT HAND CONNECTIONS ), MAGNET MOUNT.

#### 7030-33665-62

SINGLE 4" LCD MONITOR ENCLOSURE, 12 VOLT DC FOR UNDERGROUND USE WITH 5 PIN CONNECTORS ( WITH LEFT HAND CONNECTIONS ), MAGNET MOUNT.

#### 7030-35610-6

CAMERA, MCI 50 WATER TIGHT, BLACK & WHITE, 3.6 MM, FORWARD VIEWING, HIGH RESOLUTION, 600 LINES, 0.0003 LUX, 12 VDC @ 100mA WITH 5 PIN CONNECTOR

### Recommended Power Supplies

#### 1059-34534-24

IN-LINE POWER SUPPLY ASSEMBLY,  
10 - 40 VDC TO 12 VDC 2.5 AMP. WITH WEATHER PAK CONNECTORS

[www.minelinesystems.com](http://www.minelinesystems.com)

Larry Rowley @ Mining Controls Inc. Beckley, WV  
304-252-6243 ext. 1510 or 304-228-3363 cell

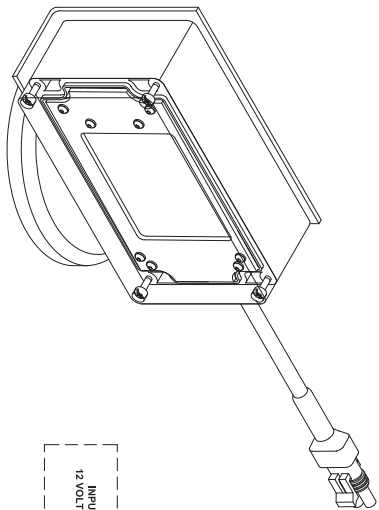

MODEL 7030-33665-60 RIGHT HAND CONNECTIONS  
 MODEL 7030-33665-62 LEFT HAND CONNECTIONS  
 SINGLE 4" LCD MONITOR ENCLOSURE 12 VOLT DC  
 FOR UNDER GROUND USE WITH 5 PIN CONNECTORS

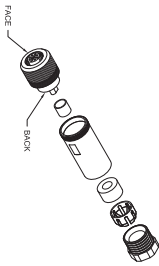
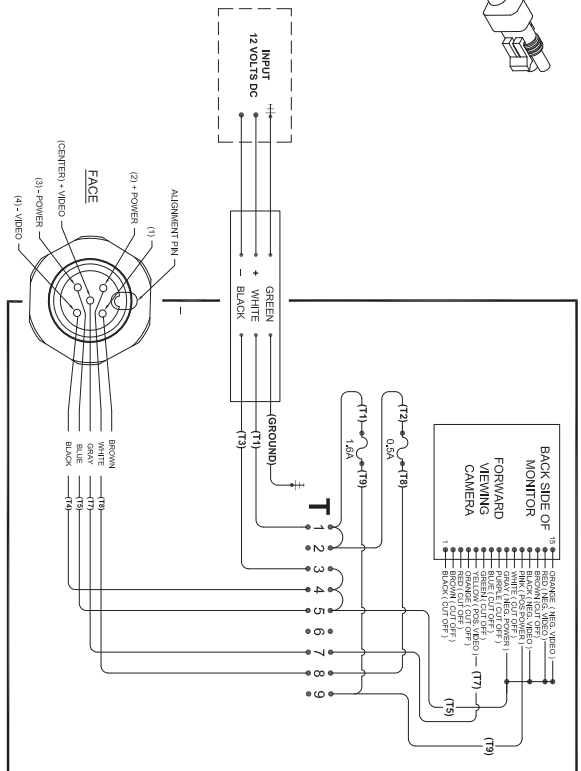

1032-33731 5 Pin Female Straight Body Connector

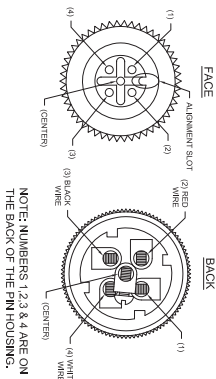

NOTE: NUMBERS 1, 2, 3 & 4 ARE ON THE BACK OF THE PIN HOUSING.

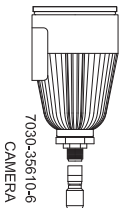

7030-35610-6 CAMERA

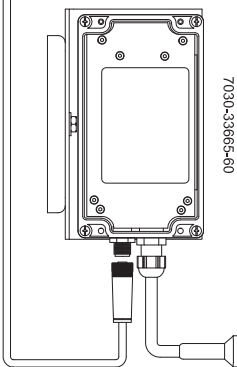

7030-33665-60

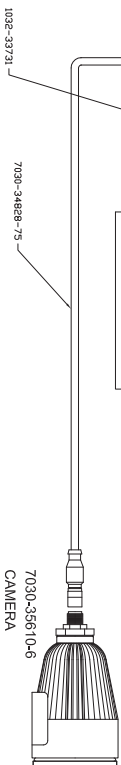

7030-34828-75 CAMERA

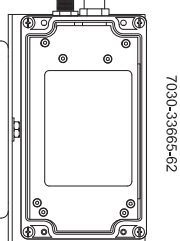

7030-33665-62

12 VDC 1 AMP.  
 INPUT + WHITE  
 - BLACK

RIB3-35600-1  
 WEATHER-PAK CABLE ASSEMBLY  
 18'-2" (5.49M) 20' LING

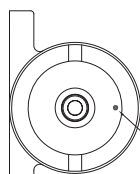

RED DOT CAMERA TOP

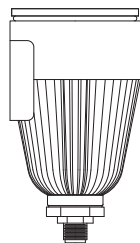

7030-35610-6  
 CAMERA MCI 50 WATER TIGHT BLACK & WHITE 3.6 MM. FORWARD VIEWING. HIGH  
 RESOLUTION 600 LINES. 0.0003 LUX. 12 VDC @ 100mA WITH 5 PIN CONNECTOR

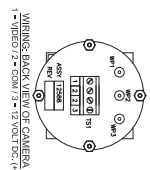

REVERSE BACK VIEW OF CAMERA  
 1 = VIDEO 2 + COM 1 = 12VDC (+)

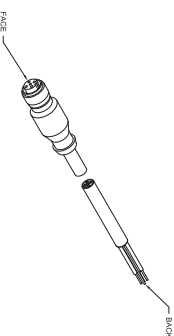
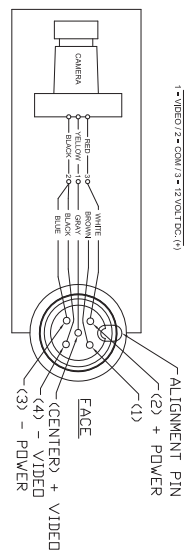

7030-34828-75 75 ft. Female Molded Cable & Connector Assembly

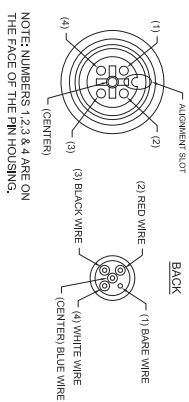

NOTE: NUMBERS 1, 2, 3 & 4 ARE ON THE FACE OF THE PIN HOUSING.



7030-35610-6 CAMERA