

1032-33731-2 4 Pin Female Straight Body Connector

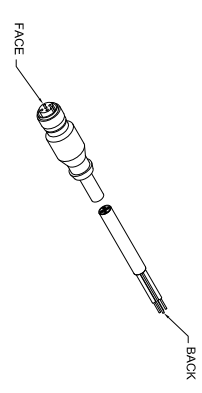

7030-34828-75 75 ft. Female Molded Cable & Connector Assembly

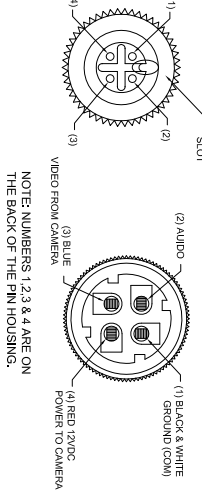
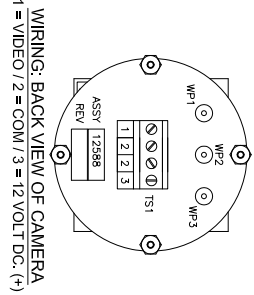
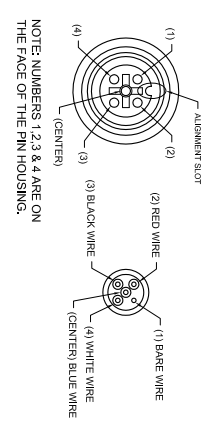

WIRING: BACK VIEW OF CAMERA
1 = VIDEO / 2 = COM / 3 = 12 VOLT DC. (+)

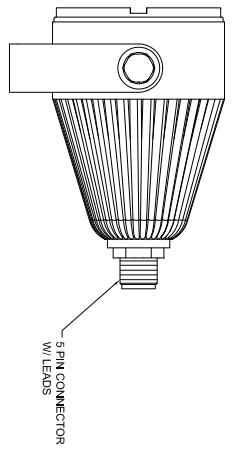

7030-36040-7
CAMERA CA 50 WATER TIGHT BLACK AND WHITE 3.6 MM. FORWARD VIEWING, HIGH RESOLUTION, 6000 LINES, 0.0003 LUX, 12 VDC @ 110mA WITH 5 PIN CONNECTOR

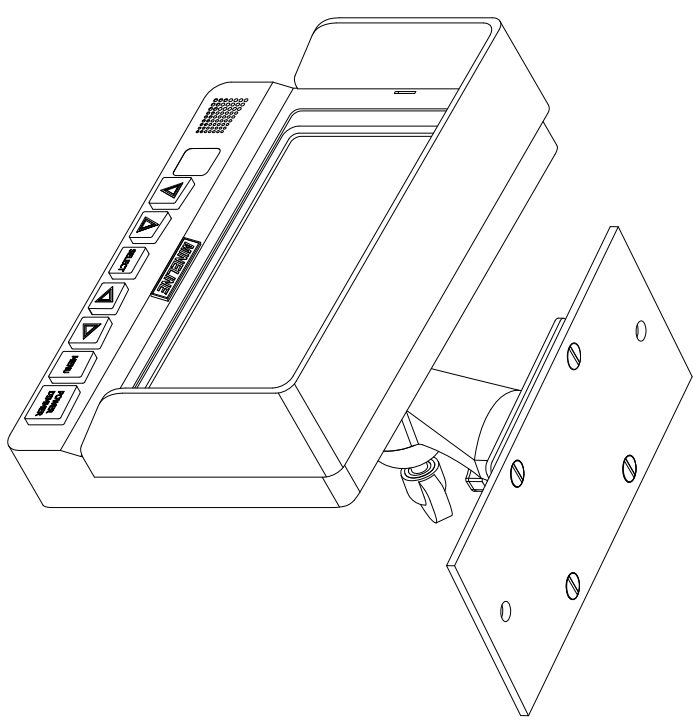

1059-34485-9
7" LCD MONITOR
DISPLAY 12VDC

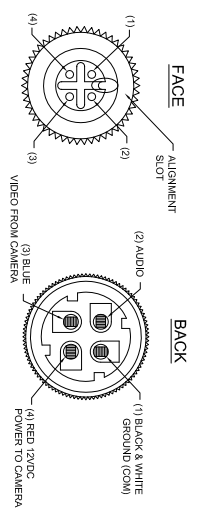
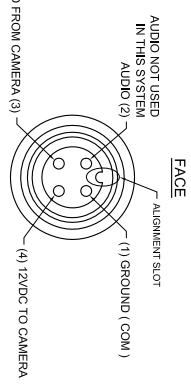
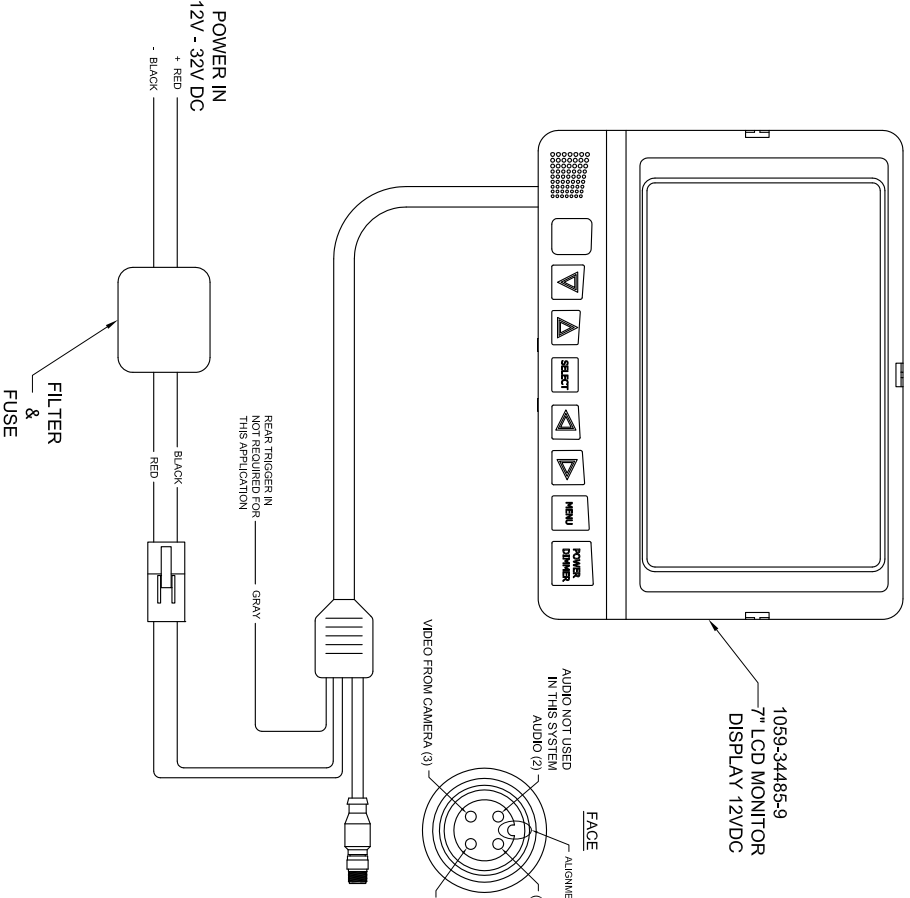

1032-33731-2
CONNECTOR 4 CONDUCTOR
ST BODY FEMALE

7030-34828-75
75 FT. MOLDED CABLE & CONNECTOR
ASSEMBLY FOR CAMERA SYSTEM

7030-36040-7

2022-35163-4
MOUNTING BRACKET

Functions

MONITOR

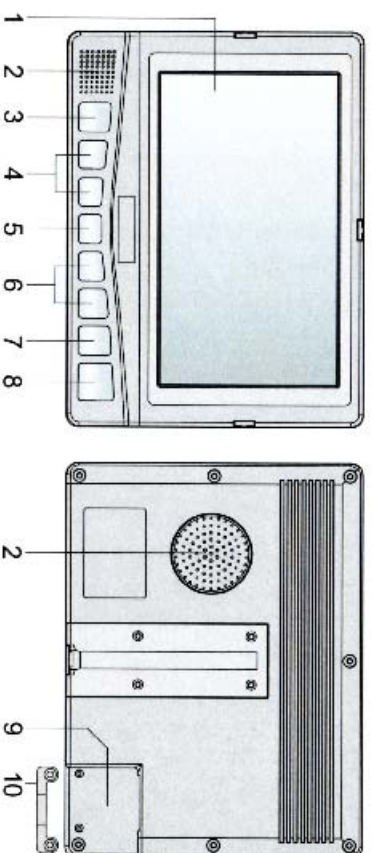

NO	MENU	DESCRIPTION
1	Protection Window	Non Reflection and protection of LCD. (Option)
2	SPEAKER	Sound out 0.5W X 2 Max.
3	IR	Remote control sensor. (Remote control is optional)
4	UP/DOWN	Use select items in the on screen menu, press UP/DOWN buttons to control rear view motorized camera. Camera 2 only.
5	CAMERA/SCAN	Press CAMERA/SCAN button to change video source. If button is held down over 1 second the setting will be changed to the auto scan mode.
6	VOLUME	Press to increase or decrease the volume and menu control.
7	MENU	Displays main menu on screen.
8	POWER/DIMMER	Press button to control dimmer. By pressing button over 1 second will turn monitor on/off. (Red LED light off)
9	CONNECTOR	Input cable (Composite Video, Audio, Power)
10	BRACKET	Bracket for fixing cable. (Option)

Operation

- ※ 1) Three view system: You can hear sound all the time.
2) On view or security camera system: Audio available only when vehicle is in reverse.

- **MENU** **M**
- Press to enter setup menu
- Selectable OSD menu disappears within 5 seconds if there is no command given.
- Menu Toggle

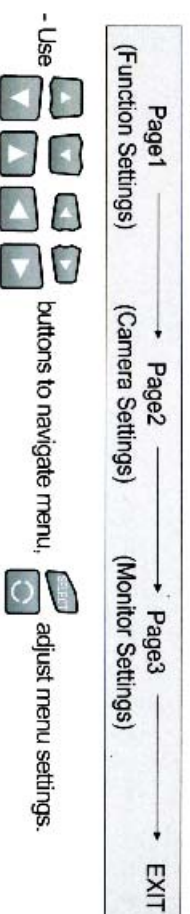

- Use buttons to navigate menu, adjust menu settings.

- A. Press 'MENU' button on the remote controller.
The following will appear on the screen.

MENU	[OFF]
AUTO SCAN	[OFF]
OSD	[OFF]
INPUT	[AUTO]
TRIGGER TIME	[800ms]
TRIGGER PRID	[REAR]
ASPECT	[WIDE]

- **AUTO SCAN** : Automatic scan when connected to video cable
- **OSD** : [ON] - OSD remains on when camera is toggled
[OFF] - OSD appears up to 5 sec when camera is toggled
- **INPUT** : [Auto] - Rear & Side view cameras automatically selected (input on mode)
[Manual] - Rear & Side view cameras manually selected (input on mode)
- **TRIGGER** : Set the priority video source when more than two trigger signals enter at the same time.
- **ASPECT** : Picture ratio control. (Wide - 16:9 / Normal - 4:3) 7 inch only.

- B. Press 'MENU' button twice on the remote controller.
The following will appear on the screen.

MENU	MIRROR	SCALE	SCAN-TIME
RIGHT	[OFF]	[OFF]	[0 sec]
REAR	[OFF]	[OFF]	[0 sec]
LEFT	[OFF]	[OFF]	[0 sec]

- **MIRROR** : Set mirror option for each video source
- **SCALE** : Ability to set scale for each video source
- **SCAN-TIME** : Ability to set the delaytime for scanning from 0 to 9 seconds

- C. Press 'MENU' button three times on the remote controller.
The following will appear on the screen.

MENU	BRIGHTNESS	[25]
	CONTRAST	[25]
	COLOR	[25]
	TINT	[25]
	SYSTEM	[NTSC]
	AUTO-ON	[ON]
	PRESET	[OFF]

- **BRIGHT** : Adjust the brightness of the screen
- **CONTRAST** : Adjust the contrast of the screen
- **COLOR** : Adjust the color of the screen
- **TINT** : Adjust the tint of the screen
- **SYSTEM** : Adjust the video format. (NTSC/PAL)
- **AUTO-ON** : The power of LCD stays on/off
- **PRESET** : Default mode

SHEET 2 of 2



MINING CONTROLS
INCORPORATED

P.O. BOX 1141 BECKLEY, WV, 26801

WIRING DIAGRAM

MONITOR, CAMERA & CONNECTOR

DATE DRAWN 4-6-11

DRAWN BY CMV

CHECKED BY

PART NUMBER

WD-7030-35365-15

REV. A